

# **Measurement Control Unit**

---

## **Z500H**

### **USER MANUAL**

**Sanmenxia ZhongyuanJingmi Co.,Ltd**

To ensure your safe use of this instrument, please follow the following instructions

**[Dangerous Matters]**

1. There is electricity inside the instrument, which poses a risk of death and personal injury when touched.
2. Do not remove the casing except for professional maintenance personnel conducting maintenance inspections.
3. Before removing the casing, it is necessary to cut off the power and unplug the power plug.

**[Warning Notice]**

1. When the measuring device is moving forward (down) or backward (up), do not reach out, otherwise it may be caught by the oil cylinder and cause injury. It should be confirmed that the installed device has stopped moving before proceeding.
2. When measuring the movement of the measuring device, reaching out and touching it can cause injury. It should be confirmed that it has stopped before proceeding.

**[Notes]**

1. Abnormal use of the measurement and control departments is strictly prohibited.
2. The outer shell is prohibited from storing heavy objects, and sitting or stepping on the electrical box is prohibited.
3. For safety reasons, the power supply and grounding wires of various components must be grounded, and the grounding point of the control instrument casing is located at the screw above the output line socket.



4. I hope to use it in the following environments

- 1) Environmental temperature: 0-40 °C.
- 2) Humidity: below 90%.
- 3) Vibration: Below 0.1G (in areas with slight vibration)

5. Panel cleaning method

- 1) The panel is made of tempered glass, please be careful to prevent scratches from hard objects.
- 2) If the panel is contaminated, please gently wipe it with a soft cloth, neutral detergent, or charged preventive agent.
- 3) Do not use organic solvents such as alcohol for cleaning.

#### **[About Carrying Abroad]**

Please inform our company in advance when taking this instrument out of the country due to various local regulations.

We are not responsible for any accidents that occur in the event of being carried abroad without declaration.

#### **[Warranty Description]**

1. This product warranty service is only valid under normal use.
2. Non product quality issues and malfunctions caused by abnormal use are not covered by warranty.

For example, malfunctions caused by the following circumstances, including but not limited to, are not covered by warranty:

- (1) The display panel was shattered due to external impact.
- (2) The user opened this product without authorization, which caused moisture and liquid ingress.
- (3) The user's wiring error or abnormal power connection caused this product to malfunction.

# Catalogue

1、 Outline	1
2、 Feature	2
3、 Interface	3
3.1、 Measurement Interface	5
3.2、 Control Point Change Interface	7
3.3、 Zeroing Interface	8
4、 I/O Interface And Connection	10
5、 Usage	12

## 1、 Outline

The Z500H control unit is an instrument designed based on the latest digital signal processing system and using the latest control technology for online monitoring and control of grinding machine processing. The system compares the measurement deviation during the grinding (cutting speed) process with the pre-set cutting amount, and sends corresponding signals to the machine tool to control the feed rate of the grinding wheel.

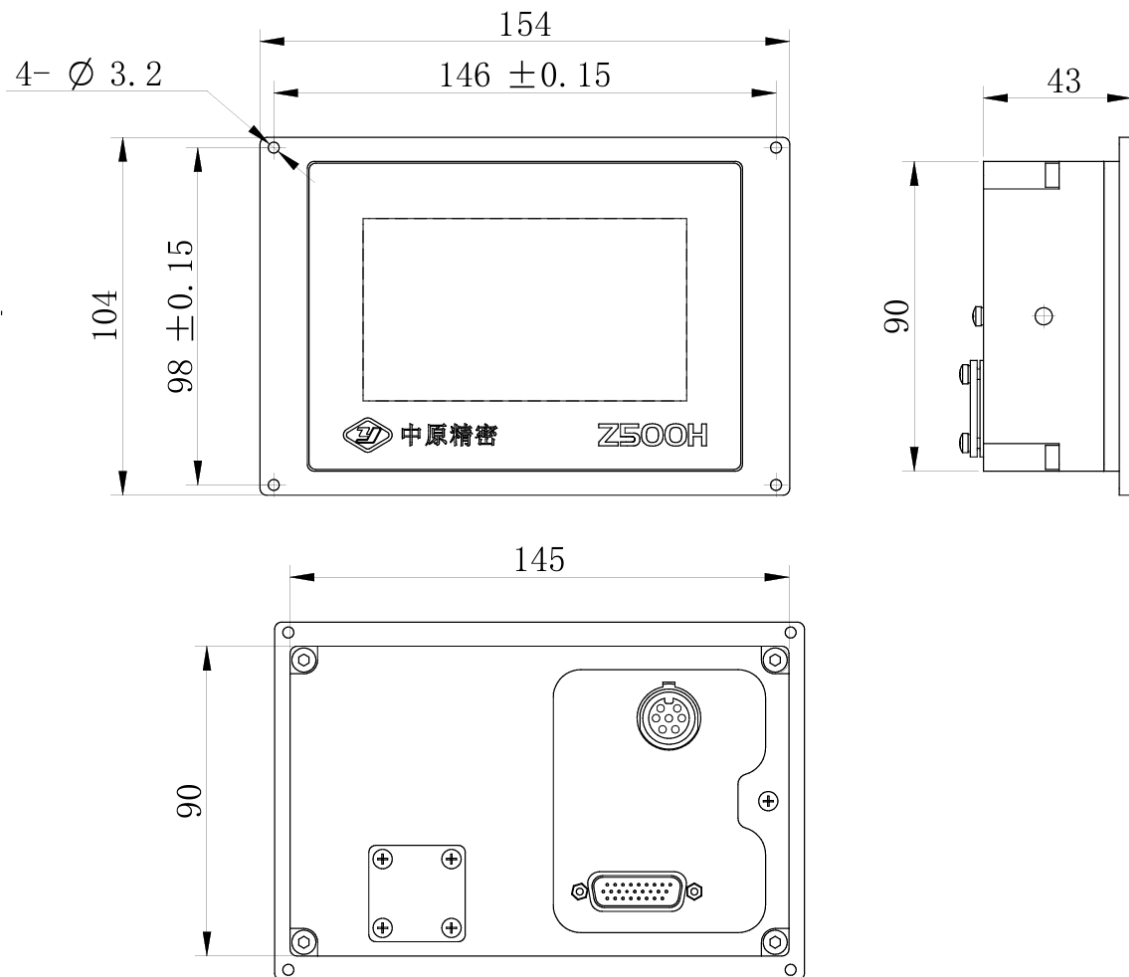

## **2、 Feature**

1) Intelligent control measurement: can perform various calculations and corrections within the standard range. During the machining measurement process, various measurement results and the status of judgment points are displayed, and signals are issued to control the action of the machine tool.

2) More convenient and compact: Equipped with a 4.3-inch LCD capacitive touch screen, embedded installation, and low-power design. Save installation space, energy conservation and environmental protection.

3) Good human-machine performance: The display interface is more intuitive and clear, the display content is richer and more comprehensive, and the operation is simpler and faster.

4) Good compatibility: In addition to improving control, display, operation, and reliability, the new controller also has higher control accuracy and is easy to install and maintain.

5) Optimized design, the entire machine meets industrial level interference testing.

### 3、 Interface

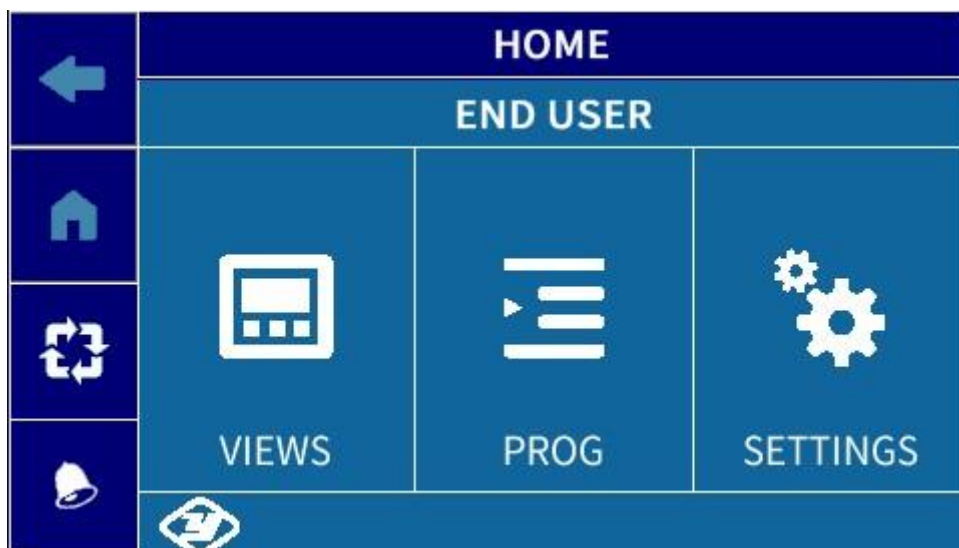

Explanation:

The Z500H controller is divided into three functional windows: display, programming, and settings. The system defaults to the main page display interface.

The main page interface provides access to the following navigation sub environments:



#### VIEWS

This menu page can be used to display measured values in different ways and make a series of adjustments, which is very useful in the grinding and measurement system settings stage.



#### PROG

The "Programming" menu page can be used to program and set the relevant parameters of the measurement cycle.







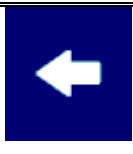

#### SETTINGS

After entering the "Settings" menu, you can set all parameters of the electronic unit and the hardware connected to it.

---

The user bar contains the following command keys:

	<p><b>Arrow</b></p>	<p>Press this button to return to the previous page.</p>
	<p><b>Main menu</b></p>	<p>Press this button to return to the main page.</p>
 	<p><b>Alarm bell</b></p>	<p>Alarm          Blue=Normal          Red=Alarm Prompt</p>
 	<p><b>Manual/Automatic</b></p>	<p>Operation mode          Small Hand Sign=Manual Mode          Loop flag=Automatic Mode</p>



### 3.1 Measurement Interface



On the "Main Page" interface, click  to enter [VIEWINGS]

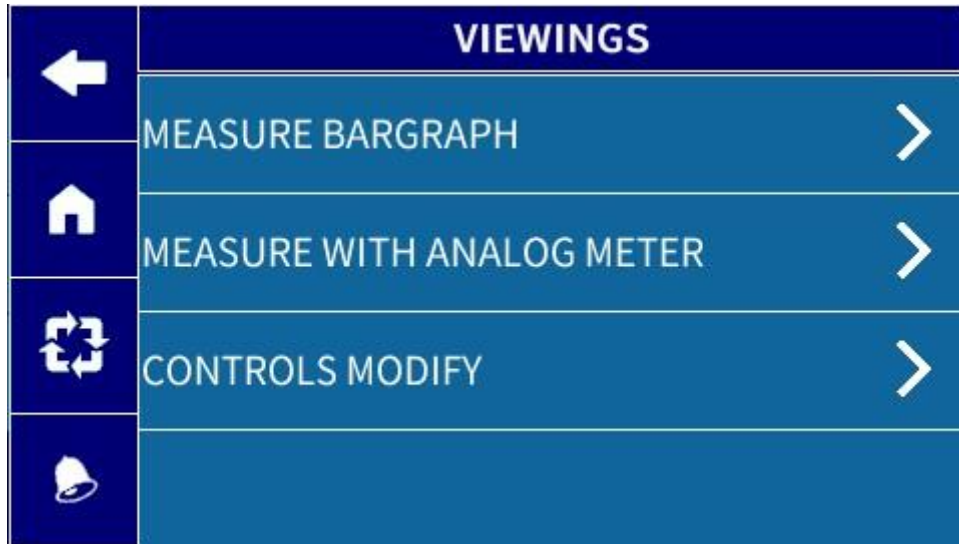

Click on [MEASURE BARGRAPH] to enter the automatic measurement interface, as shown in the following figure:

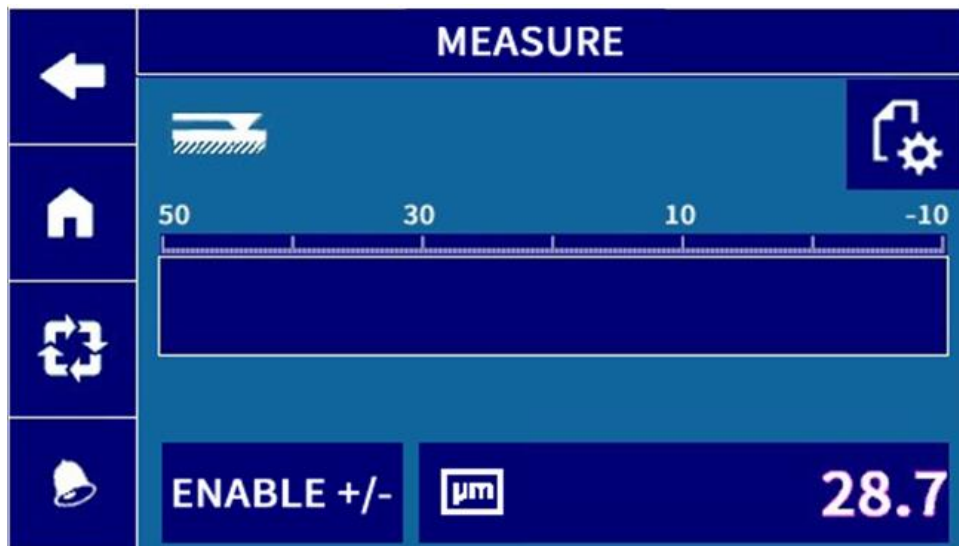

**Window function:** Display the measured values of the measurement project in numerical form and adjust the zero position.

**Explanation:**

**28.7**: Display the measured values of the measurement items ,



**ENABLE +/-**: Click to perform 0.5 additional adjustments

: Click to enter the "Zero Adjustment" interface.

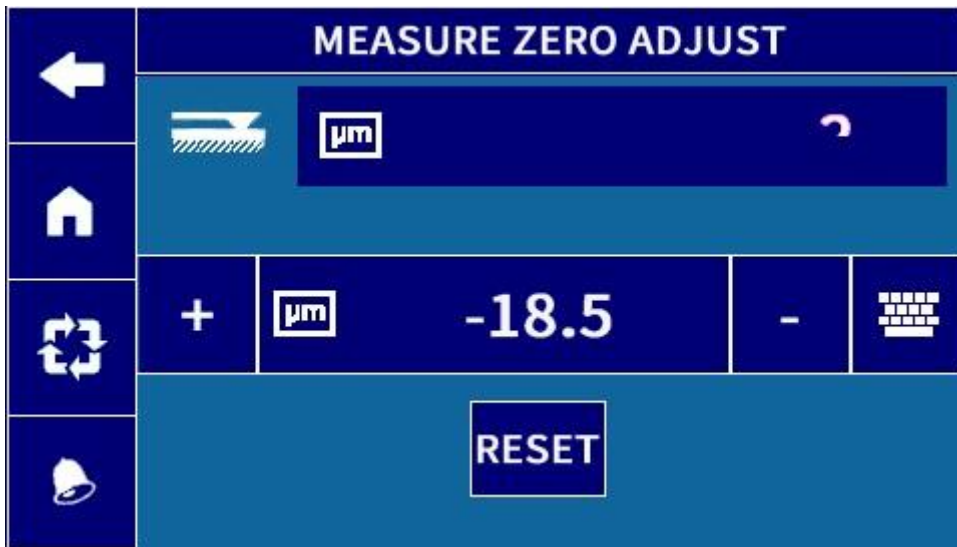
The zero adjustment interface is as follows:



说明:

  Press the button to increase or decrease the measured value by 1  $\mu$  m.

: After clicking, enter the numerical setting keyboard interface.



After entering the desired value, you need to press the "CONFIRM" button to save the changes, or press the "Cancel" button to discard the changes.

**Note: The range of zero adjustment is -50~+50.**



: In automatic mode, only in this mode will the controller output a signal to reach the desired position during the machining process.

### 3.2 Control Point Change Interface

In automatic mode, press "Control Point Change" on the observation interface and jump to the following interface:

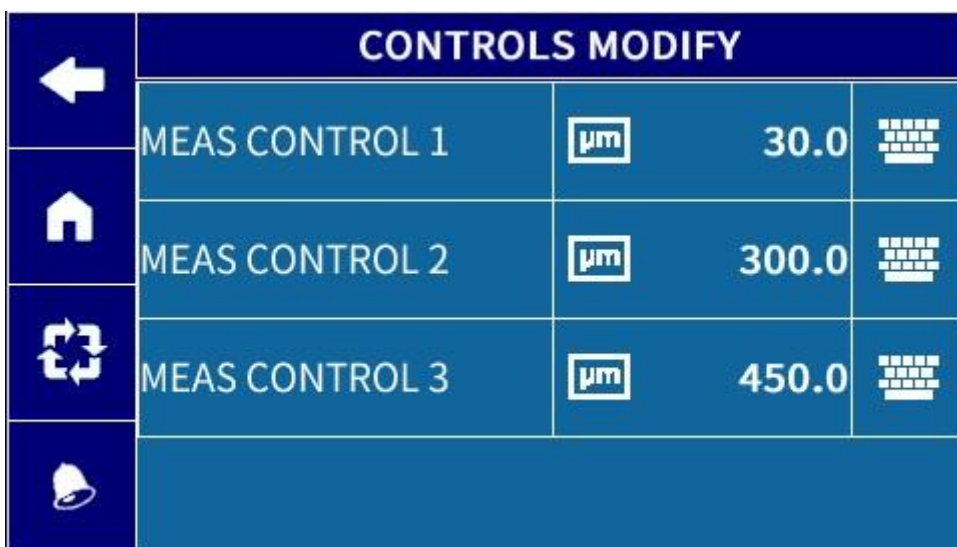

To change the setting parameters, click on the corresponding button on the right side , the keyboard appears for setting.

Explanation:

MEAS CONTROL 3: Brief grinding signal point;

MEAS CONTROL 2: Refined grinding signal point;

MEAS CONTROL 1: Buffing grinding signal point;

The default signal point for tool retraction is 0;

Setting values: MEAS CONTROL 3>MEAS CONTROL 2>MEAS CONTROL 1;

### 3.3 Zeroing interface (manual mode)

Press  in the automatic measurement interface to switch to the manual measurement interface, as shown below:

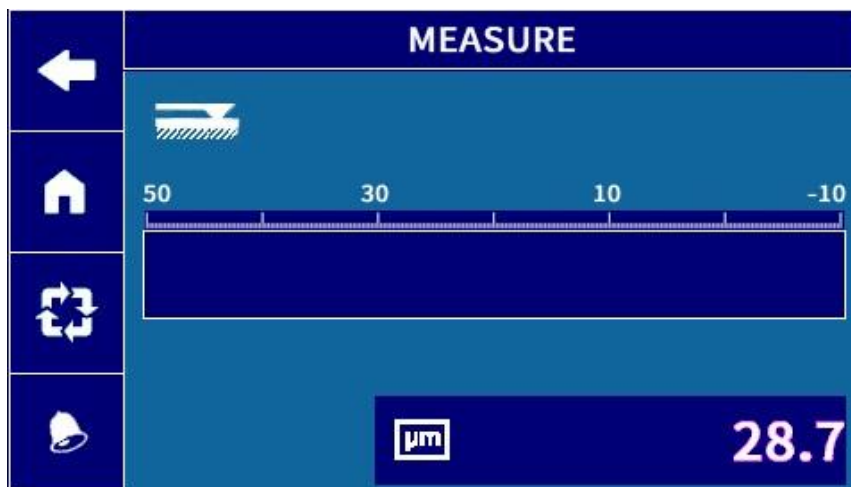

In the manual measurement interface, press  to enter the reset interface, as shown in the following figure:

←	ZEROINGS	
	TRANSDUCER 1	TRANSDUCER 2
🏠	7.3	7.3
🧤	ZEROING	RESET
🔔	μm	28.8

**ZEROING**: After pressing it, reset the measured value to zero (28.8 in the above figure will become 0.0);

**RESET**: After pressing it, reset the zero point (28.8 is shown again in the above figure);

**Note: The values of TRANSDUCER 1 and 2 can be reset between -50 and+50**

## 4 、 I/O Interface And Connection

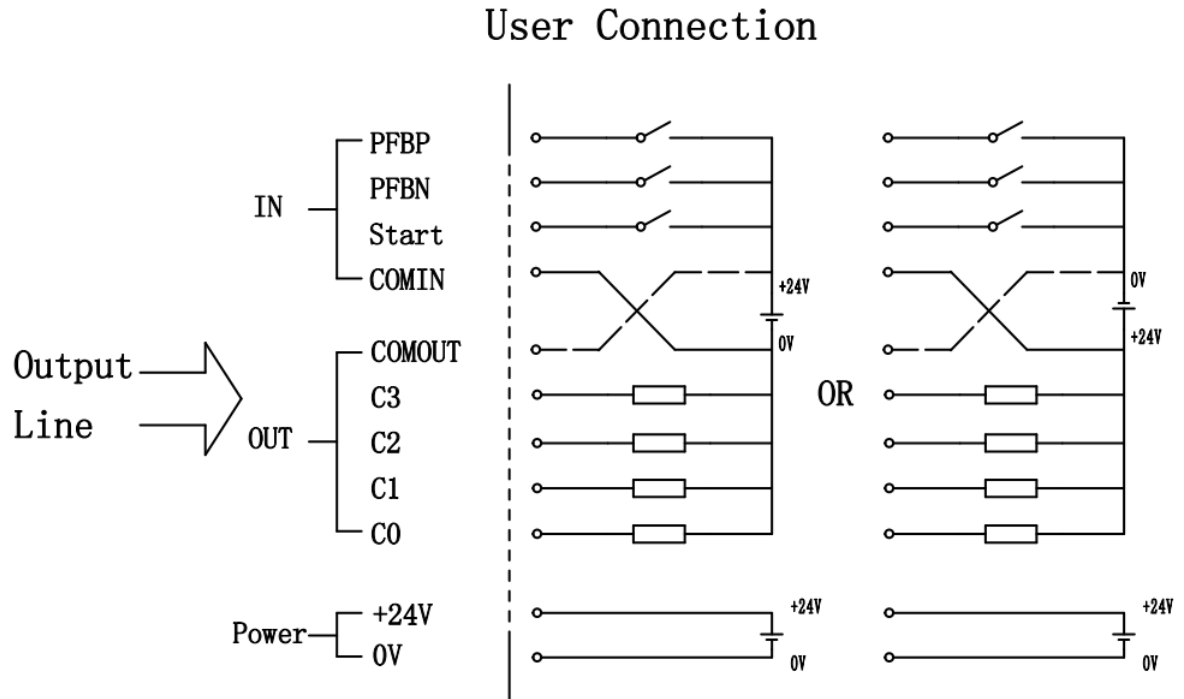

I/O parameters:

Power supply: 24VDC  $\pm$  20% (>10W)

24V connection output line purple and red lines

0V connected to the black output line

Input/output signal: optocoupler 24V 3mA

Ground wire: Connect the grounding bolt to the machine tool ground wire

**Output line wiring table**

<b>Number</b>	<b>I/O</b>	<b>Line color</b>	<b>Remarks</b>
1	OUT_C0	Light green	
2	-	Grey	
3	-	Black/White	
4	OUT_C1	Brown/White	
5	OUT_C2	Yellow	
6	OUT_C3	Red/White	
7	OUT_AUTO	Orange/White	
8	DC: +24V	Purple	
9	DC: +24V	Red	
10		Pink/Black	
11		Grey/Black	
12		Blue	
13	OUT_DELAY	Green	
14	OUT_ALARM	Brown	
15	OUT_RETRACTED	Pink	
16	COMIN	White	
17		Green/White	
18		Blue/White	
19	COMOUT	Green/Black	
20	IN_PFBP	Yellow/Black	External adjustment+ (increase grinding allowance)
21	IN_PFBN	Orange/Black	External adjustment - (reducing grinding allowance)
22	IN_RETRACTION	Red/Black	
23	IN_START	Purple/White	
24	IN_ZEROING	Orange	
25			
26	DC: 0V	Black	

## 5、 Usage

After booting up and entering the main page interface, enter the reset interface in manual mode.

	ZEROINGS	
	TRANSDUCER 1	TRANSDUCER 2
	7.3	7.3
	ZEROING	RESET
		28.8

Before the oil cylinder drive device enters the measuring station, adjust the position of the upper and lower sensors of the device to ensure that the surface of the standard workpiece cannot contact the upper and lower sensors. After the device enters the measurement station, adjust the upper measuring element slightly to change the displayed value to around 0 (within  $\pm 10$ ), and lock the upper measuring element tightly; Adjust the measuring element again in the same way, and finally press **ZEROING**. Press the return button to enter the manual measurement interface, then press the  controller to enter automatic measurement mode.

The control instrument has been precisely adjusted according to the standard when leaving the factory, and there is no need to adjust the magnification during normal use. Programming and setting interfaces do not require parameter changes.



**V1.0 202404**



## **Sanmenxia ZhongyuanJingmi Co.,Ltd**

**Address: East Section of Weiliu Road, Sanmenxia Urban-Rural**

**Integration Demonstration Zone, Henan Province, China**

**Tel: 0398-2751818 Fax: 0398-2751819**

**Postcode: 472000**

**<http://www.zyjm.com>**